

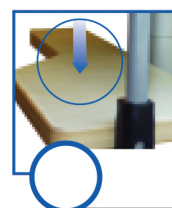













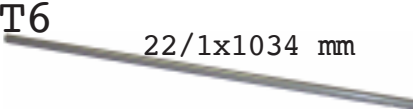
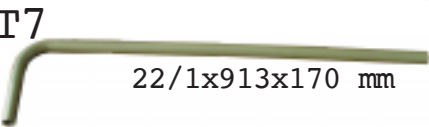





172-228

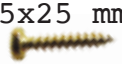
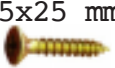

200

| | | |
|-----|--|---------------|
| T1 |  | 11 x - 920491 |
| T2 |  | 1 x - 920489 |
| T3 |  | 1 x - 920487 |
| T4 |  | 1 x - 920485 |
| T5 |  | 12 x - 931052 |
| T6 |  22/1x1034 mm | 1 x - 920497 |
| T7 |  22/1x913x170 mm | 7 x - 932112 |
| T10 |  | 7 x - 930623 |
| T11 |  | 11 x - 930851 |
| T12 |  | 9 x - 931586 |
| T13 |  | 9 x - 932032 |

| | | |
|-----|---|---------------|
| T14 | M10  | 4 x - 931061 |
| T15 |  | 2 x - 930630 |
| T16 | M10x8  | 24 x - 931062 |
| T17 | 5x25 mm  | 72 x - 932067 |
| T18 | 4,5x25 mm  | 27 x - 931752 |
| T19 |  | 8 x - 931733 |
| T20 | M8  | 8 x - 931078 |
| T21 | M8x70  | 8 x - 931735 |
| T22 | M6x6  | 23 x - 930632 |
| T23 |  | 23 x - 930633 |
| T24 | M10x70  | 2 x - 931060 |

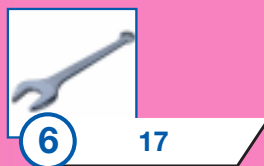
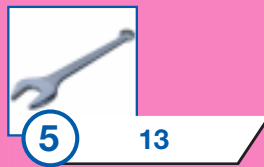
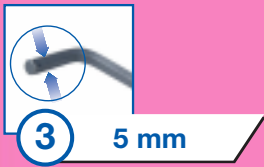
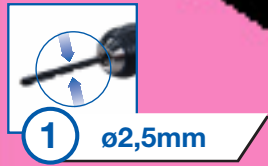
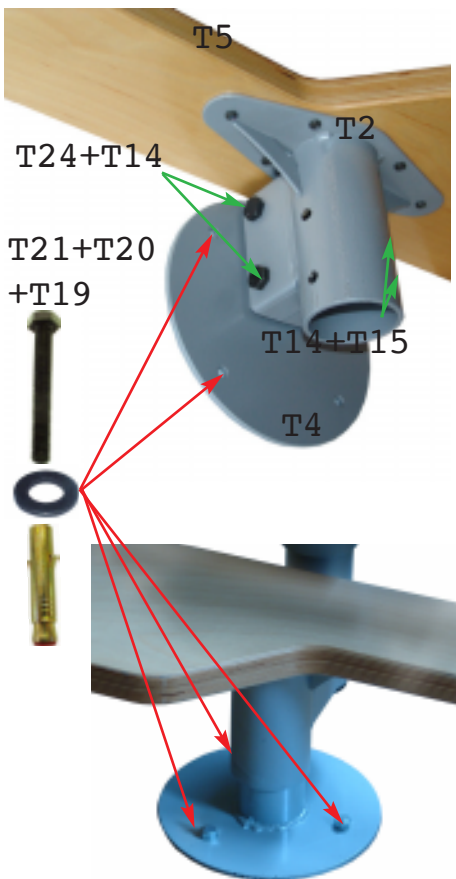
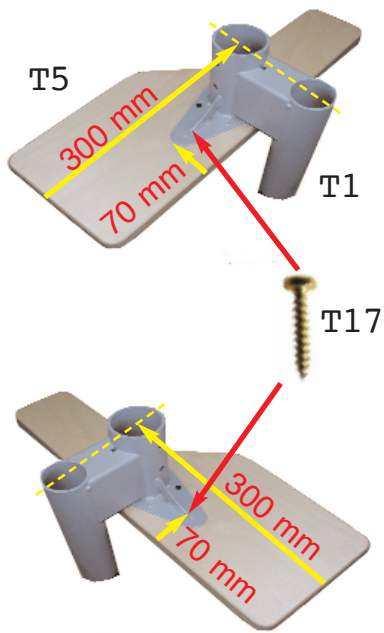

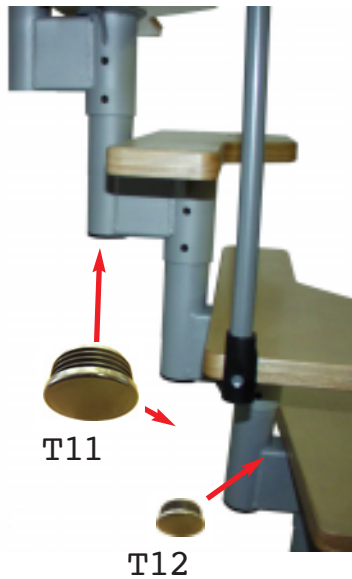

T11

T12

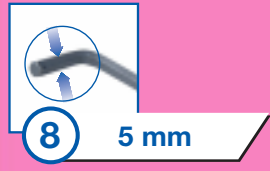

8 5 mm

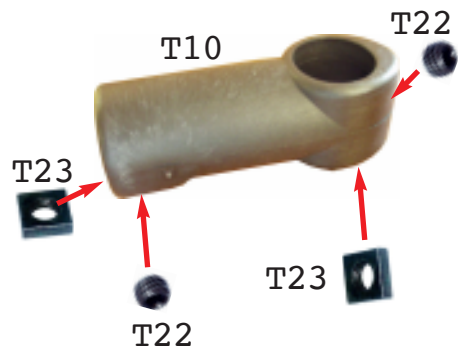

T10

T22

T23

T23

T22

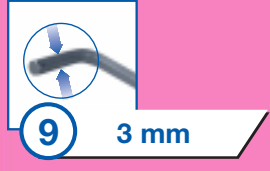

9 3 mm



T13

T22

T23

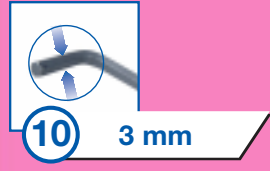

10 3 mm



11 190-210mm

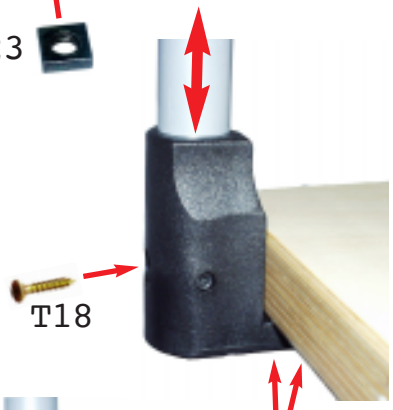

T18



12 -

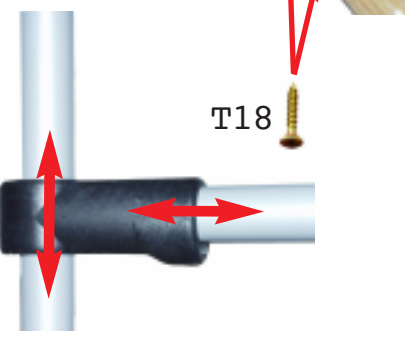

T18



13 3 mm

